

# Gauge Isolator Valve (PUSH TO READ), Model : GI



the right connection  
the right environment

Ref. No : H03542, Release March 2018 (Dimensions in mm)

## Description

The pressure gauge isolator valve model GI is meant for checking the system pressure to which it is connected.

The valve is a spool type, spring off-set, manually operated device.

In normal condition the valve blocks the pressure port and keeps the pressure gauge connected to the drain. Thus isolating the gauge from system pressure surges and eliminating continuous pressure strain on the gauge.

By pushing the actuator knob of the valve, system pressure can be read on the gauge.

The valve is available either for mounting on a sub-plate or with threaded ports.

The pressure gauge can either be directly mounted on the valve or can be connected remotely.

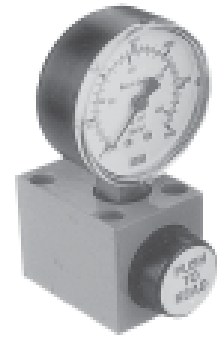

## Section

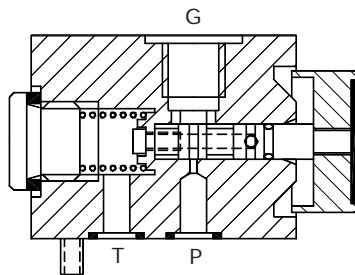

Hydraulic Symbol

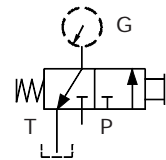

## Unit Dimensions

Model GIM - Sub-plate mounting Valve

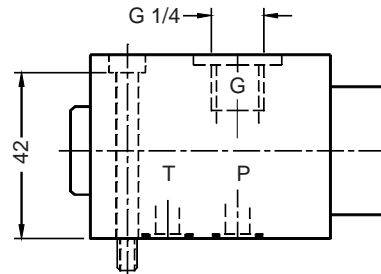
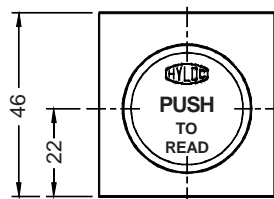
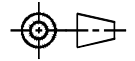

### Mounting Interface

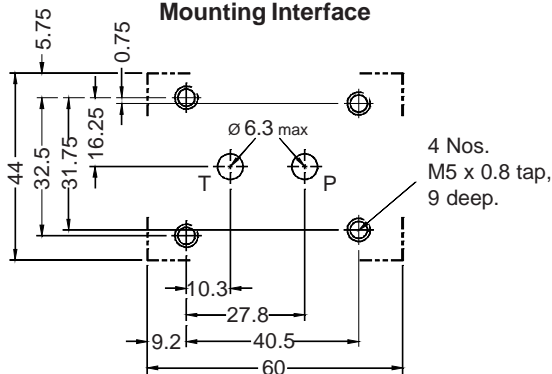

M5 x 50 L S.H.C. Screw 4 Nos.  
(Not included in scope of supply)  
Tightening torque 15 Nm.

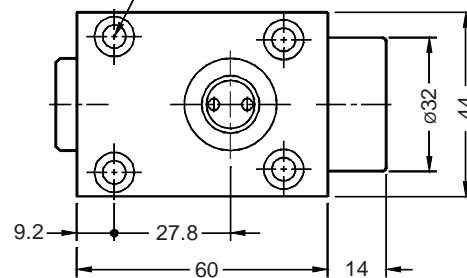

# Gauge Isolator Valve (PUSH TO READ), Model : GI



the right connection  
the right environment

Ref. No : H03542, Release March 2018 (Dimensions in mm)

Model GIP - Valve with threaded ports

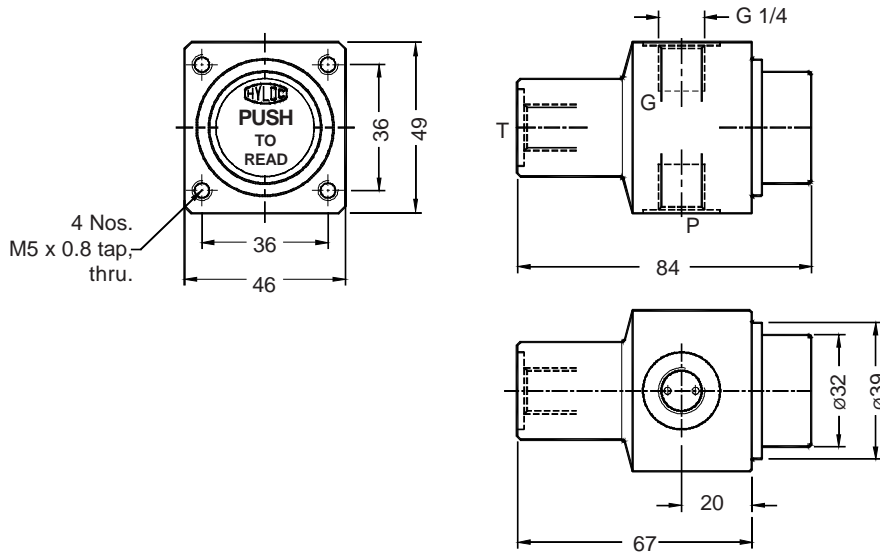

## Technical Specifications

- Construction . . . . . Spool type, manually operated, spring off-set.
- Mounting . . . . . Sub-plate mounting, conforming to  
IS 10187  
ISO 4401 - AB - 03 - 4 - A  
DIN 24340 (Only `A' and `B' ports used.)
- Mounting position . . . . . Optional
- Flow direction . . . . . As indicated by the hydraulic symbol.
- Operating pressure . . . . . 210 bar.
- Hydraulic medium . . . . . Mineral oil.
- Viscosity range . . . . . 10 cSt to 380 cSt.
- Fluid temperature range . . . . . -10 °C to +80 °C.
- Fluid cleanliness requirement . . . . . As per ISO 19/16 or better.

## Ordering Code

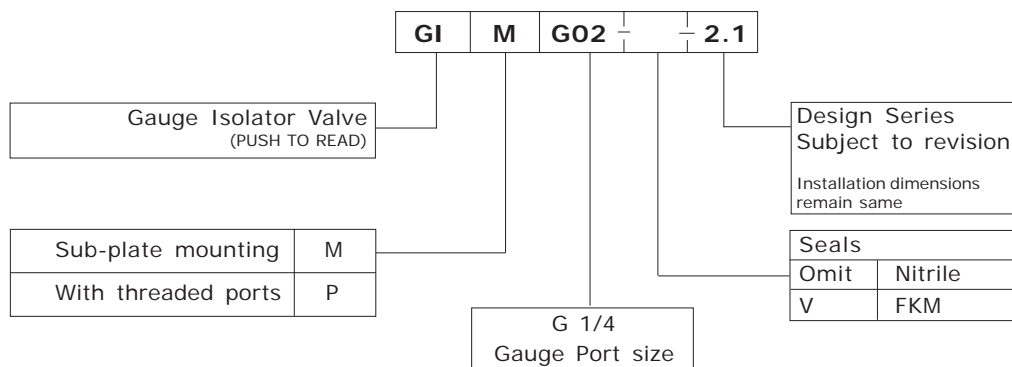

Note : To mount Pressure gauges having G 3/8 or G 1/2 end connection, use of Gauge mounting Adaptor is recommended. Consult [marketing@hyloc.co.in](mailto:marketing@hyloc.co.in)