

Pressure Gauge Isolator Valve, Model : 1GI



the right connection
the right environment

Ref. No : H03154 Release August 2014 (Dimensions in mm)

Description

- Seat type valve.
- Swivelling gauge connection for easy gauge positioning.
- Compact assembly.
- Eliminates gauge supporting bracket.
- Angular gauge face plane in Sub-plate mounting construction facilitating easy gauge reading.



Section

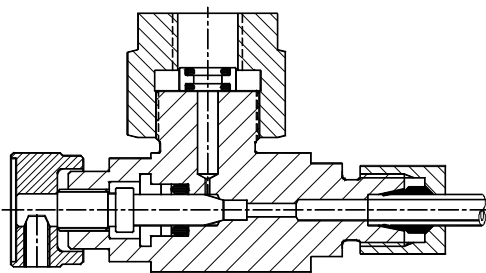

Panel Mounting

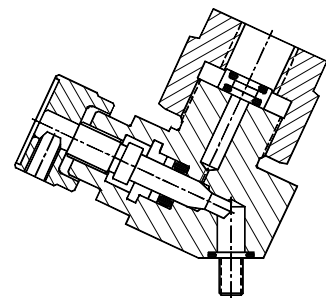

Sub-plate Mounting



Hydraulic Symbol

Unit Dimensions

Panel Mounting Valve

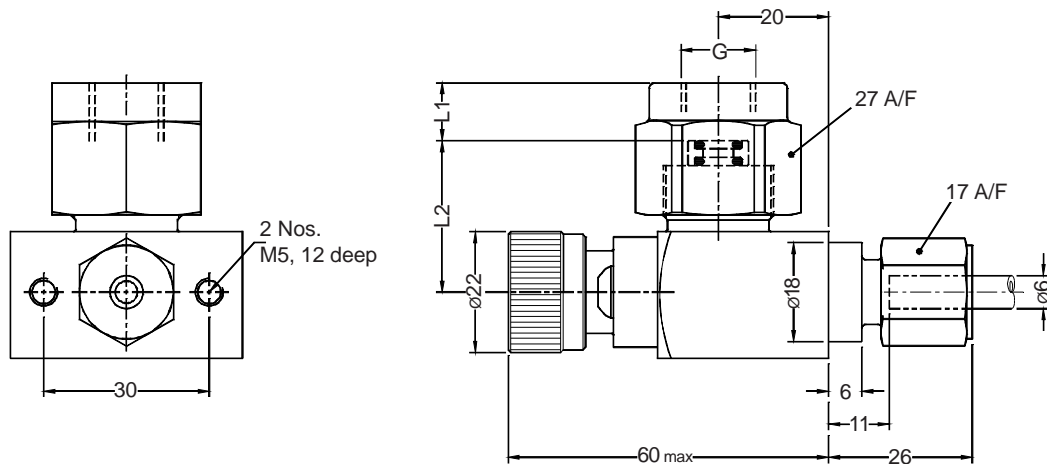
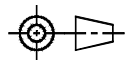

G	G 1/4	G 3/8	G 1/2
L1	10.5	10.5	12.5
L2	27.5	28.0	28.0

Pressure Gauge Isolator Valve, Model : 1GI



the right connection
the right environment

Ref. No : H03154 Release August 2014 (Dimensions in mm)

Sub-plate Mounting Valve

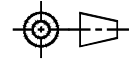
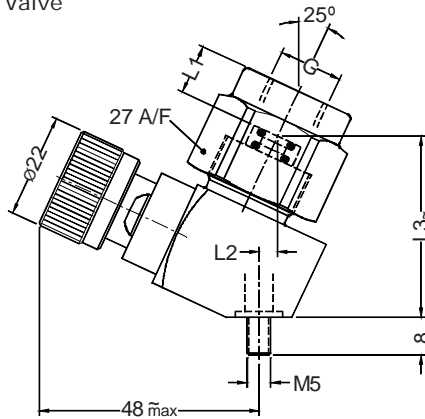

G	G 1/4	G 3/8	G 1/2
L1	10.5	10.5	12.5
L2	4.0	4.0	4.0
L3	38.5	39.0	39.0

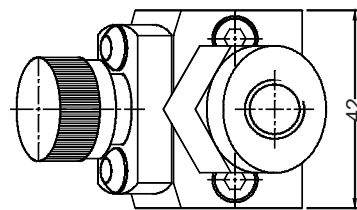

Valve Interface

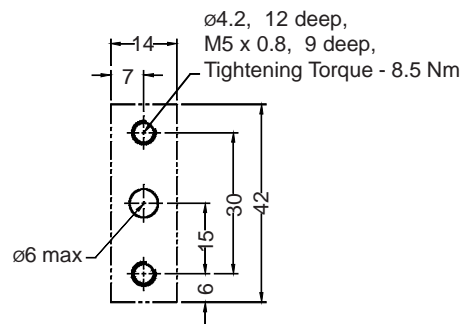

Technical Specifications

- Construction Seat type.
- Mounting Sub-plate mounting interface/Panel mounting (Threaded body)
- Interface standard Factory standard.
- Mounting position Optional
- Operating pressure 350 bar.
- Hydraulic medium Mineral oil.
- Viscosity range 10 cSt to 380 cSt.
- Fluid temperature range -20 °C to +70 °C.
- Fluid cleanliness requirement As per ISO 19/16 or better.
- Mass 0.3 Kg.

Ordering Code

